

DIMENSIONS - MM

Part Number	A	B	C	D	E	F	G	H	I
10000	139.5	80.0	120.0	32.0	65.0	1/8" (F)	350.0	7.0	8.40

* All measurements in millimeters, unless otherwise noted.
** All fittings are NPT, unless otherwise noted.

DIMENSIONS - IN

Part Number	A	B	C	D	E	F	G	H	I
10000	5.49	3.15	4.72	1.26	2.56	1/8" (F)	13.78	0.28	0.33

* All measurements in inches, unless otherwise noted.
** All fittings are NPT, unless otherwise noted.

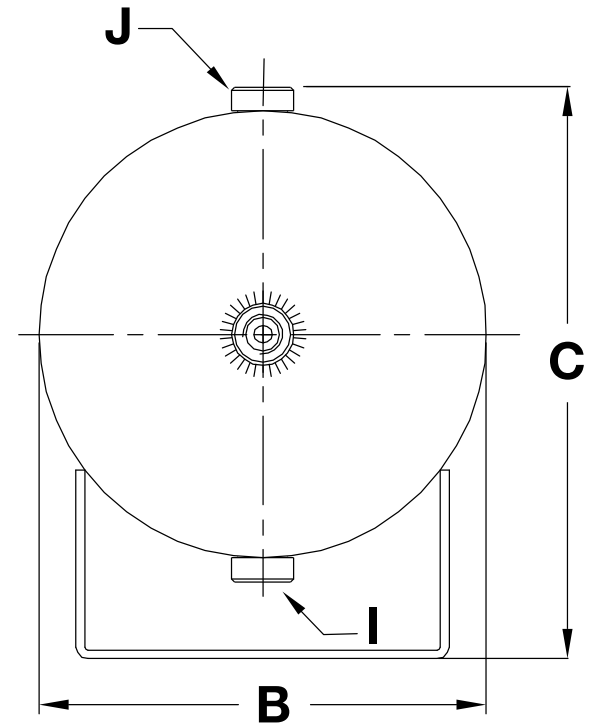
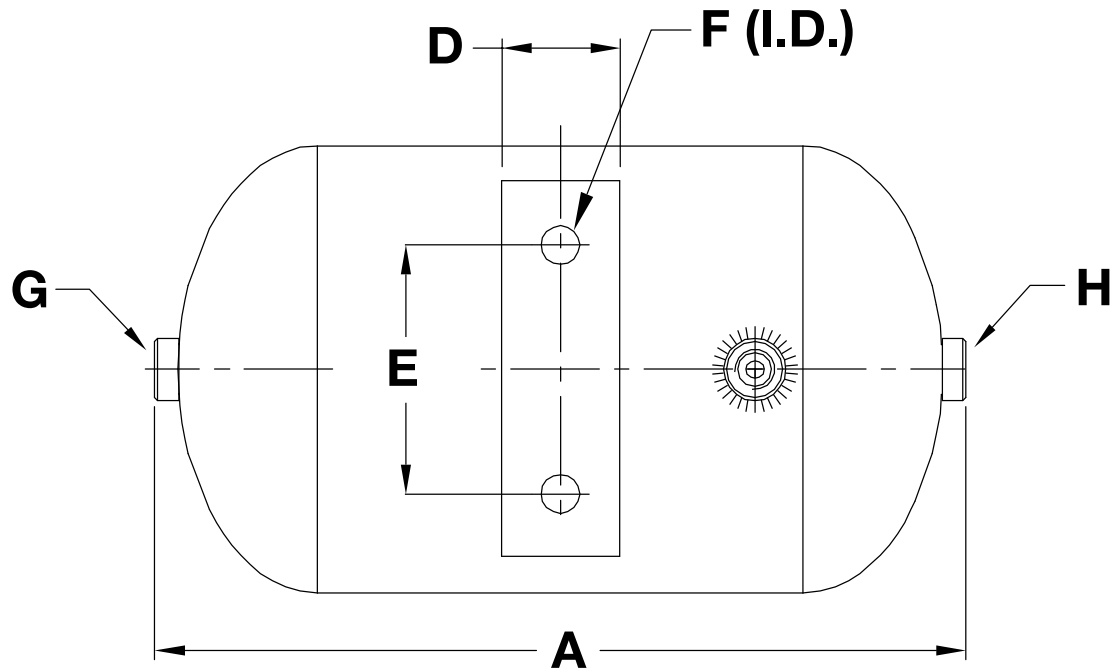

DIMENSIONS - MM

Part Number	A	B	C	D	E	F	G	H	I	J
91014	273.7	151.0	193.5	40.0	84.0	5.1	1/4" (F)	1/4" (F)	1/4" (F)	1/4" (F)

* All measurements in millimeters, unless otherwise noted.

** All fittings are NPT, unless otherwise noted.

DIMENSIONS - IN

Part Number	A	B	C	D	E	F	G	H	I	J
91014	10.78	5.94	7.62	1.57	3.31	0.20	1/4" (F)	1/4" (F)	1/4" (F)	1/4" (F)

* All measurements in inches, unless otherwise noted.

** All fittings are NPT, unless otherwise noted.